

# CONTENTS

OF YOUR OWNER'S MANUAL

## CONTENTS

<b>Introduction</b> .....	<b>1</b>
• Welcome .....	1
• Features .....	1
• Included in Your Package .....	2
<b>Installing and Adjusting Your Phone</b> .....	<b>3</b>
• Desk/Tabletop Installation .....	3
• Wall Installation .....	4
• Installing the Handset Battery Pack .....	10
• Charging the Battery Pack .....	11
• Cleaning the Battery Contacts .....	12
• Setting the Pulse/Tone Switch .....	12
• Adjusting the Handset Volume Controls .....	13
• Installing the Beltclip .....	14
• Headset Installation .....	15
• Automatic Digital Code Security .....	15
<b>Using Your New Phone</b> .....	<b>16</b>
• Making and Receiving Calls .....	16
• Flash and Call Waiting .....	16
• Storing a Phone Number in Memory .....	17
• Editing a Phone Number in Memory .....	18
• Erasing a Number from Memory .....	19
• Using Memory Dialing .....	20
• Traveling Out-of-Range .....	20
• Using Caller ID .....	21
• Using Redial .....	25
• Using the Tone Feature .....	25
• Using the Page Feature .....	26
<b>Troubleshooting</b> .....	<b>27</b>
• Quick Reference Chart .....	27
<b>Specifications</b> .....	<b>29</b>

Fold out the back cover of this owner's manual to use the handy "Controls and Functions" page for reference.

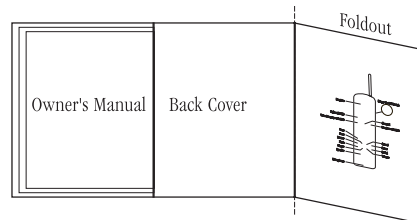

# INTRODUCTION

TO YOUR NEW PHONE

INTRODUCTION

## WELCOME

Congratulations on your purchase of the Uniden EXS9600 cordless telephone. This phone is designed for reliability, long life, and outstanding performance utilizing the latest in 900 MHz Spread Spectrum technology.

## FEATURES

- 900 MHz Spread Spectrum Technology
- Caller ID and Call Waiting Caller ID
- 50 Number Caller ID Memory
- 3-Line, 16 Character Backlit LCD Handset Display
- 10 Enhanced Memory Dial Locations
- 32 Digit Redial
- 2nd Battery Capability
- Back-up Power Supply with Optional Battery Pack
- Redial, Flash, and Pause
- Pulse/Tone Dialing
- Page
- 7 Day Standby Battery Time
- 4 Hour Talk Time
- Handset Earpiece and Ringer Volume Control
- Hearing Aid Compatible

**Digital Spread Spectrum Technology** utilizes a “wider frequency band” vs. a “single narrow band” used in standard digital transmissions. The result is a more secure conversation with the clarity of digital sound, extended range, and minimal interference from other cordless phones.

**Random Code™** digital security automatically selects one of over 65,000 codes for the handset and base.

These features enhance your phone's security and also prevent unauthorized calls as a result of your phone being activated by other equipment.

**TIP**

To get the most from your phone, please read this owner's manual thoroughly. Also be sure to complete and mail the product registration form.

**NOTE**

If any of these items are missing or damaged, contact the Uniden Parts Department at (800)554-3988. Hours are from 8:00 a.m. to 5:00 p.m. Central Time, Monday through Friday. We can also be reached on the web at [www.uniden.com](http://www.uniden.com).

**INCLUDED IN YOUR PACKAGE**



Handset

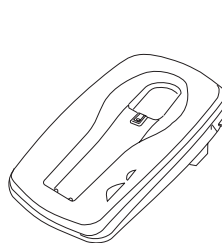

Base

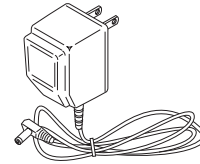

AC Adapter



Rechargeable Battery

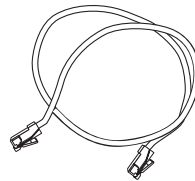

Short Telephone Cord



Beltclip

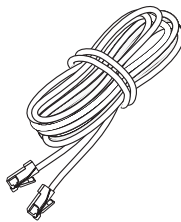

Long Telephone Cord

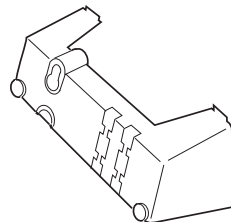

Desktop/ Wall Mount Adapter

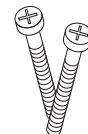

Wall Mounting Screws

- This Owner's Manual
- Precautions and Important Safety Instructions
- Registration Card

### TIP

Before choosing a location for your phone, read the "Installation Considerations" included in the "Precautions and Important Safety Instructions" brochure.

## DESK/TABLETOP INSTALLATION

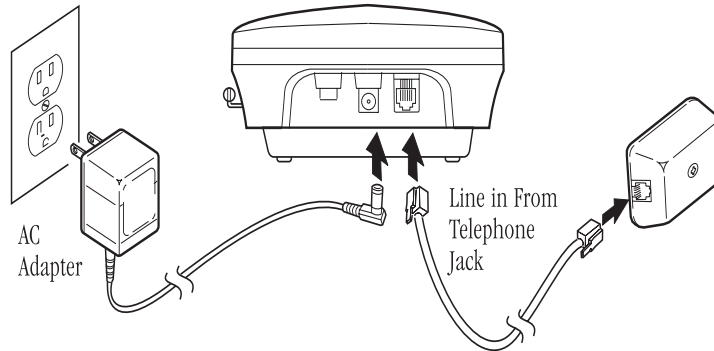

- 1) Plug the AC adapter cord into the 9 VDC input jack on the back of the base.
- 2) Wrap the AC adapter cord around the strain relief notch.



*Place the power cord so that it does not create a trip hazard or where it could become chafed and create a fire or electrical hazard.*

- 3) Plug the AC adapter into a standard 120 VAC wall outlet.



*Use only the Uniden AC adapter supplied with this phone and DO NOT use an outlet controlled by a wall switch.*

- 4) Charge the battery (refer to "Charging the Battery Pack," page 11).
- 5) Plug one end of the long telephone cord into the **TEL LINE** jack on the back of the base.
- 6) Plug the other end of the cord into your telephone jack on the wall.

INSTALLING  
AND ADJUSTING YOUR PHONE

INSTALLING AND ADJUSTING



Before using your phone, fully charge the Nickel-Cadmium battery pack for 15-20 hours.



Place the power cord so that it does not create a trip hazard or where it could become chafed and create a fire or electrical hazard.

7) Attach the desktop stand to the base.

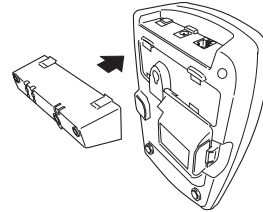

8) Set the base on a desk or tabletop and place the handset into the base. Then, raise the antenna to a vertical position.

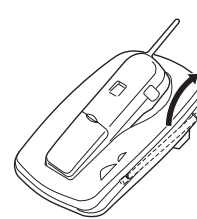

## WALL INSTALLATION

### ▼ *Standard wall plate mounting*

This phone can be mounted on any standard AT&T or GTE wall plate.

1) Remove the mounting adapter from the notches at the top of the base.

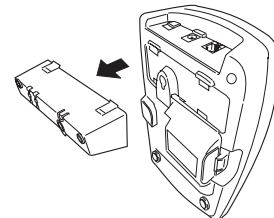

2) Rotate the mounting adapter 180° and snap it into place at the bottom of the base.

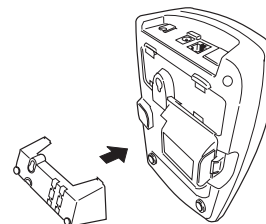



DO NOT use an outlet controlled by a wall switch.



Before you plug the other end of the telephone cord into the modular jack on the wall, charge the battery (refer to "Charging the Battery Pack," page 11).

3) Plug the AC adapter cord into the 9 VDC input jack on the back of the base.

4) Put the AC adapter cord inside the molded wiring channel, then wrap it around the strain relief notch. Plug the AC adapter into a standard 120 VAC wall outlet.

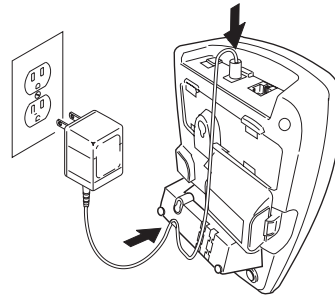

5) Plug one end of the short telephone cord into the **TEL LINE** jack on the back of the base, then plug the other end into a standard telephone jack.

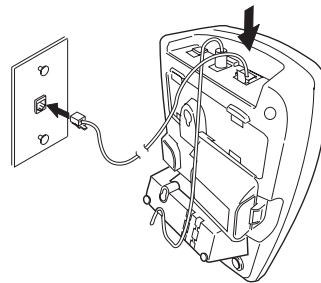

6) Line up the mounting slots on the base with the mounting posts on the wall, then push in and down until the phone is firmly seated.

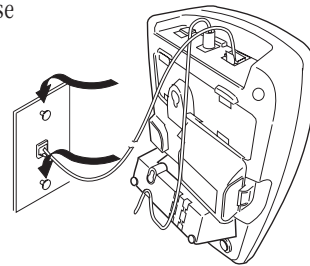

INSTALLING AND ADJUSTING

- 7) On the base unit, pull the handset retainer out of the slot and rotate it clockwise 180°.

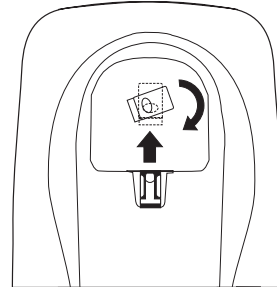

- 8) Flip the retainer from front to back, then slide it back into the slot so that the lip of the retainer faces up and the oval is at the bottom of the retainer. This will hold the handset in place.

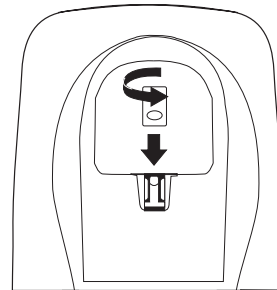

▼ *Direct wall mounting*

If you don't have a standard wall plate, you can mount your phone directly to the wall. Before doing this, consider the following:

- Select a location away from electrical cables, pipes, or other items behind the mounting location. Inserting screws into areas such as this can be hazardous.
- Try to mount your phone within 10 - 15 feet of a working phone jack in order to avoid excessive cord lengths. Remember, you are not mounting to a wall plate with a built in phone jack.
- If the selected mounting area has no wooden support beams directly behind it, you will need the appropriate anchoring devices in order for the wall to properly support your phone.

- 1) Insert two mounting screws into the wall, with their appropriate anchoring device, 3-15/16 inches apart. Allow about 3/16 of an inch between the wall and screw heads for mounting the phone.

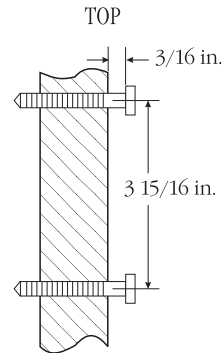

- 2) Remove the mounting adapter from the notches at the top of the base.

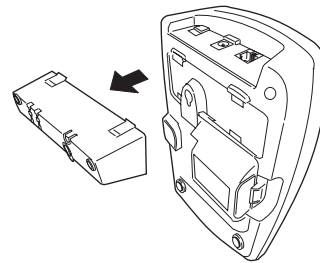

Be careful not to insert the mounting screws into possible electrical hazards such as cables, wiring, or pipes.



- 3) Rotate the mounting adapter 180° and snap it into place at the bottom of the base.

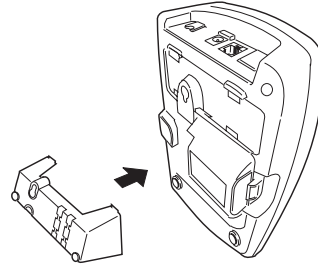

- 4) Plug the AC adapter cord into the 9 VDC input jack on the back of the base.

- 5) Put the AC adapter cord inside the molded wiring channel, then wrap it around the strain relief notch. Plug the AC adapter into a standard 120 VAC wall outlet.

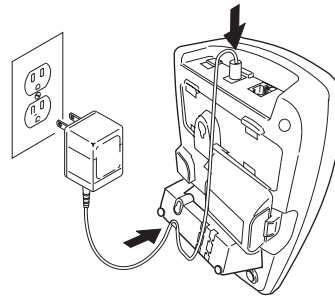

- 6) Plug one end of the long telephone cord into the **TEL LINE** jack on the back of the base, then plug the other end into a standard telephone jack.

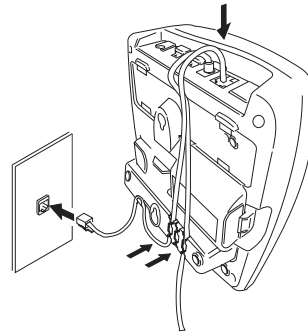

- 7) Line up the mounting slots on the base with the mounting screws on the wall, then push in and down until the phone is firmly seated.

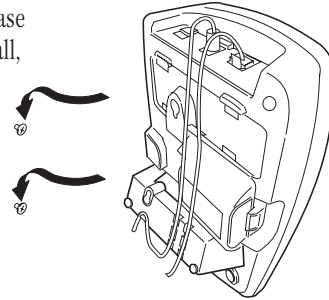

- 8) On the base unit, pull the handset retainer out of the slot and rotate it clockwise 180°.

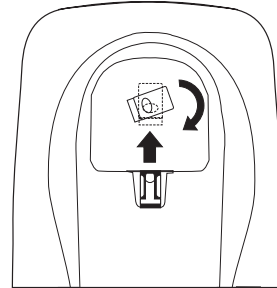

- 9) Flip the retainer from front to back, then slide it into the slot so that the lip of the retainer faces up and the oval is at the bottom of the retainer. This will hold the handset in place.

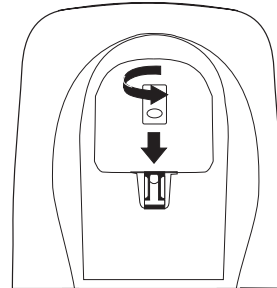

**INSTALLING AND ADJUSTING**



Use only Uniden battery model (BT-990) supplied with your phone.

## INSTALLING THE HANDSET BATTERY PACK

- 1) Press in on the battery cover release and slide the cover down until it comes off.

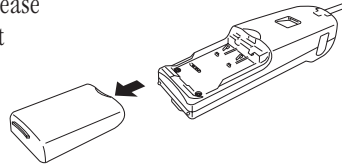

- 2) Install the nickel-cadmium battery with the label facing down.

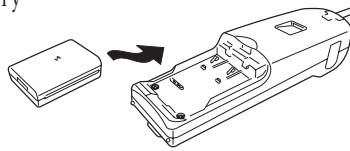

- 3) Slide the battery cover on until it snaps into place.

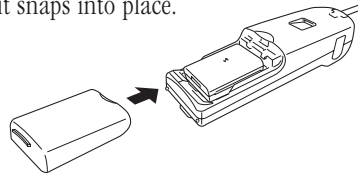

## CHARGING THE BATTERY PACK

### ▼ *Initial battery charging*

Before plugging the phone line into your new phone for the first time, fully charge the battery pack for 15-20 hours *without interruption*.

- 1) Place the handset on the base.
- 2) Make sure that **status** LED lights. If the LED doesn't light, check to see that the AC adapter is plugged in and that the handset makes good contact with the base charging contacts.

### ▼ *Charging optional battery packs*

The base unit of your phone is equipped with a compartment for charging an extra battery pack for use in your handset. **You can obtain an extra battery pack from your authorized Uniden dealer.**

- 1) Position the battery pack so the inner side with contacts is facing up.
- 2) Slide the battery pack into the charging compartment until it clicks into place.

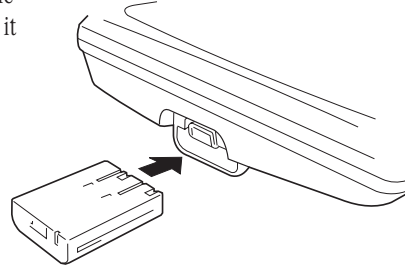

- 3) Charge the battery for 24 hours. When charging is complete, pull up on the latch to remove the battery pack. To install the charged battery into the handset, refer to "Installing the Handset Battery Pack," page 10.



*In the event of a power failure, your spare battery pack can be used as a back-up power supply for the base unit.*

### NOTE

Please visit your authorized Uniden dealer to obtain an extra battery pack or contact the Uniden parts department at (800)554-3988. Hours are from 8:00 a.m. to 5:00 p.m. Central Time, Monday through Friday.

### ▼ *Low battery indicator*

When the battery pack is very low and needs to be charged, the phone is programmed to eliminate functions in order to save power. If the phone is not in use, **Low Battery** flashes. If the phone is in use, **Low Battery** flashes and the handset beeps. Complete your conversation as quickly as possible and return the handset to the base for charging.

**Low Battery**

### **CLEANING THE BATTERY CONTACTS**

To maintain a good charge, clean all charging contacts on the handset and base about once a month with a pencil eraser or other contact cleaner. DO NOT use liquids or solvents; you may damage your phone.

### **SETTING THE PULSE/TONE SWITCH**

Be sure the **PULSE/TONE** switch is in the **TONE** position unless your local phone system uses pulse dialing.

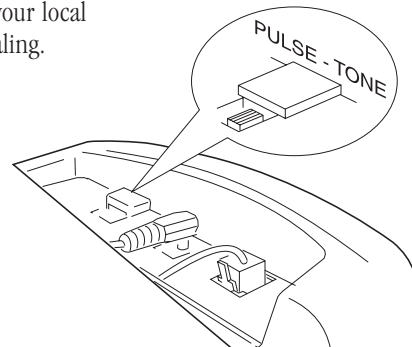

### **TIP**

Most phone systems use tone dialing. Check with your local phone company if you're not sure whether your system is tone or pulse.

## ADJUSTING THE HANDSET VOLUME CONTROLS

### ▼ *Handset ringer volume*

When the phone is in standby mode, pressing the **vol ▲** or **▼** key on the handset selects the handset ringer volume. There are two ringer volume settings; high and low.

To select the high volume setting, press **vol ▲**. The handset displays Ringer High.

Ringer High

To select the low volume setting, press **vol ▼**. The handset displays Ringer Low.

Ringer Low

### ▼ *Handset earpiece volume*

There are three volume settings for the handset earpiece; high, normal, and low. The handset earpiece volume can only be adjusted during a call.

To lower the volume, press **vol ▼**, and to raise the volume, press **vol ▲**. The handset will display Volume High, Volume Normal, or Volume Low, indicating the current volume setting.

**IMPORTANT**

Use only the Uniden HS910 headset specifically designed for Spread Spectrum phones. You will hear a buzz or hum on other headsets.

**IMPORTANT**

Keep headset wire away from base antenna.

**NOTE**

If you are using an optional headset, you must still use the handset keypad for phone operations.

**INSTALLING THE BELTCLIP**

▼ *To attach the beltclip*

- 1) Remove the slot cover.

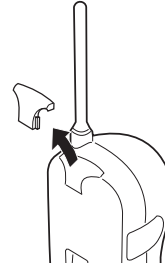

- 2) Insert the beltclip into the empty slot and press down until it clicks.

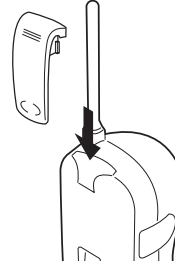

▼ *To remove the beltclip*

- 1) Pull back on the release tab and pull the beltclip up.

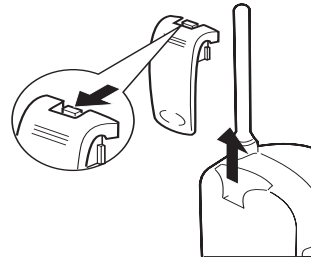

- 2) Replace the slot cover. You can store either the beltclip or slot cover on the bottom of the base.

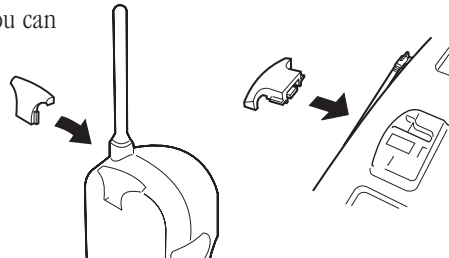

## HEADSET INSTALLATION

Your phone may be used with an optional headset, the Uniden HS910. To use this feature, simply insert the headset plug into the headset jack. Your headset is ready for hands-free conversations.

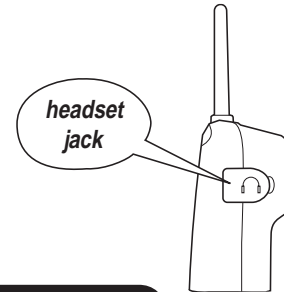

## AUTOMATIC DIGITAL CODE SECURITY



To prevent other parties from making unauthorized calls on your phone line, a digital code was added to the EXS9600. Your phone's handset and base share this code, which is randomly set each time you place the handset in the charging cradle. If the phone experiences a power failure, you must reset the digital security code.

### ▼ *To reset the digital security code*

- 1) Restore power to the base
- 2) Place the handset on the base. The **status** LED blinks to indicate that the digital security code is reset.



**MAKING AND RECEIVING CALLS**

	Handset On Base 	Handset Off Base 
To answer a call	1) Pick up the handset. 2) If not in Autotalk Mode, press <b>talk</b> .	1) Press any key. 2) If not in Autotalk Mode, press <b>talk</b> .
To make a call	1) Pick up the handset. 2) Press <b>talk</b> . 3) Listen for the dial tone. 4) Dial the number.  <b>OR</b> Dial the number, then press talk.	1) Press <b>talk</b> . 2) Listen for the dial tone. 3) Dial the number.  <b>OR</b> Dial the number, then press talk.
To hang up	Press <b>talk</b> , or return the handset to the base (AutoStandby).	
To redial	1) Pick up the handset. 2) Press <b>talk</b> . 3) Listen for the dial tone. 4) Press <b>redial</b> .	1) Press <b>talk</b> . 2) Listen for the dial tone. 3) Press <b>redial</b> .

**FLASH AND CALL WAITING**

If you have “call waiting” service and a call waiting tone sounds while you are on a call, press **flash** to accept the waiting call. There is a short pause, then you will hear the new caller. To return to the original caller, press **flash** again.

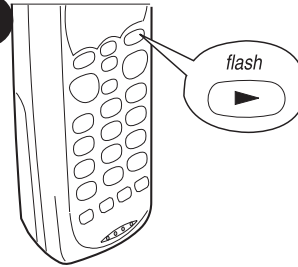

### NOTE

Whenever you are using a menu screen, you must press a key within 20 seconds or the phone will return to standby. You may also press **memory** to exit a memory menu at any time.

### HINT

The character menu consists of letters, symbols, and numbers.

### HINT

The “-” does nothing to the dialing sequence. It simply allows you to display a dash.

### NOTE

The pause button counts as one digit. Pressing **pause** more than once increases the length of pause between numbers.

## STORING A PHONE NUMBER IN MEMORY

1) Remove the handset from the base.

2) Press and hold **memory** for two seconds. The following screen appears.

```
Memory Store
1▶
2
```

3) Use the ▲ and ▼ keys or number keypad to choose the memory location where you would like to enter a number.

4) Press **select**. The following screen appears, and a cursor flashes indicating that the display is ready for the name to be entered.

```
Store Name
█
```

5) Use the ▲ and ▼ keys to scroll through the character menu. Use the ◀ and ▶ keys to move the cursor to the desired location, and enter the name.

6) Press **select**. The following screen appears, and a cursor flashes indicating that the display is ready for the number.

```
Store Number
█
```

7) Enter the phone number with the number keypad (direct entry) or the ▲ and ▼ keys. Use the ▲ and ▼ keys to enter symbols, such as dashes. Use the ◀ and ▶ keys to move the cursor to the desired location, and enter the number.

### NOTE

*When entering numbers, press **pause** to enter a pause in the dialing sequence. The display shows a P. The pause feature is useful for long distance calling, credit card dialing, or sequences requiring a pause between digits.*

8) Press **select**. The handset beeps and displays a confirmation screen. For example, if you store a name and number into memory location number one, the display shows **Memory 1 Stored**.

```
Memory 1 Stored
```

9) Press **memory** or return the handset to the charging cradle to exit store mode. Or, wait 20 seconds for the phone to return to standby.

### NOTE

Whenever you are using a menu screen, you must press a key within 20 seconds or the phone will return to standby. You may also press **memory** to exit a memory menu at any time.

### NOTE

If you select **Go Back** at any time, no changes are made and the handset shows the Memory Store screen.

### HINT

The “-” does nothing to the dialing sequence. It simply allows you to display a dash.

## EDITING A PHONE NUMBER IN MEMORY

Follow these steps to edit a phone number that you have already programmed into memory.

- 1) Remove the handset from the base.

- 2) Press and hold **memory** for two seconds. The display shows the Memory Store screen and any saved numbers.

```
Memory Store
1▶ KAYSIE SCHLITZ
2 UNIDEN
```

- 3) Use the ▲ and ▼ keys or number keypad to select the memory location you would like to edit. The ◀ and ▶ keys toggle between the names display and the numbers display.

- 4) Press **select**. The following screen appears with the memory location number that you have selected in the display.

```
▶ Edit Memory 1
Delete Memory 1
Go Back
```

### NOTE

*You may move the ▶ cursor down to Go Back and press **select** if you would like to exit this menu.*

- 5) With ▶ cursor next to **Edit Memory**, press **select**. The following screen appears, and a cursor flashes indicating that the display is ready for the name to be edited.

```
Store Name
KAYSIE SCHLITZ
```

- 6) Use the ▲ and ▼ keys to scroll through the character menu. Use the ◀ and ▶ keys to move the cursor to the desired location, and enter the name.

- 7) Press **select**. The following screen appears, and a cursor flashes indicating that the display is ready for the number to be edited.

```
Store Number
8175551212
```

- 8) Enter the phone number with the number keypad (direct entry) or the ▲ and ▼ keys. Use the ▲ and ▼ keys to enter symbols, such as dashes. Use the ◀ and ▶ keys to move the cursor to the desired location, and enter the number.

- 8) Press **select**. The handset beeps and displays a confirmation screen. For example, if you store a name and number into memory location number one, then the handset shows **Memory 1 Stored**.

```
Memory 1 Stored
```

- 9) The display then returns to the Memory Store screen. You may select another number to edit (return to step 3) or you may press **memory** to return to standby.

### ERASING A NUMBER FROM MEMORY

Use these steps to erase a programmed number from memory. Once a number is erased, that memory location may be programmed with a new number.

- 1) Remove the handset from the base.

- 2) Press and hold **memory** for two seconds. The handset shows the Memory Store screen with any saved numbers displayed.

```
Memory Store  
1▶ KAYSIE SCHLITZ  
2 UNIDEN
```

- 3) Use the ▲ and ▼ keys or number keypad to select the memory location you would like to delete. The ◀ and ▶ keys toggle between the names display and the numbers display.

- 4) Press **select**. The following screen appears with the memory location number that you have selected in the display.

```
▶ Edit Memory 1  
Delete Memory 1  
Go Back
```

- 5) Use the ▼ key to move the ▶ cursor down to the **Delete Memory** command.

```
Edit Memory 1  
▶ Delete Memory 1  
Go Back
```

- 6) Press **select**. The following confirmation screen appears.

```
Delete Memory?  
Yes  
▶ No
```

- 7) Use the ▲ key to move the ▶ cursor to the **Yes** command.

#### NOTE

If you select **Go Back** at any time, no changes are made and the handset shows the Memory Store screen.

#### NOTE

If you select **No**, no changes are made and the handset shows the Memory Store screen.



Use the ◀ and ▶ keys to toggle between the names and the numbers displayed in memory.

- 8) Press **select**. There is a confirmation tone, and the handset displays **Memory 1 Deleted**.

Memory 1 Deleted

- 9) The display then returns to the Memory Store screen. You may select another number to delete (return to step 3) or you may press **memory** to return to standby.

### USING MEMORY DIALING

Follow the steps below to dial a number using a programmed memory location.

- 1) Press **memory**. The handset displays your programmed memory locations.

1▶ KAYSIE SCHLITZ  
2 Uniden  
3 Grandma

- 2) Use the ▲ and ▼ keys or the number keypad to select the memory location you would like to dial.

1 KAYSIE SCHLITZ  
2▶ Uniden  
3 Grandma

- 3) Press **talk** and the number dials.



*When the handset is removed from the base, press **talk** then **memory** on the handset keypad before selecting the memory location.*

### TRAVELING OUT-OF-RANGE

As you begin to move too far from your base unit, you will first hear a clicking sound. As you travel further out-of-range, the voice transmission will begin to break up. If you pass the range limits of the base unit, your call will terminate.

## USING CALLER ID

**You must subscribe to Caller ID from your phone company in order to use this feature.**

### ▼ *Setting up Caller ID options*

There are three Caller ID setup options available; they are Autotalk, CIDCW, and Area Code.

**AutoTalk** allows you to answer the phone without pressing the **talk** button. If the phone rings when Autotalk is on, simply remove the handset from the cradle and the phone automatically answers the call. If the phone rings when Autotalk is off, you must press **talk** to answer the call. This option is useful to help you screen your calls more effectively.

CIDCW performs the same as regular Caller ID on a call waiting number. **You must subscribe to CIDCW from your phone company in order to use this feature.**

The **Area Code** feature is used when storing or directly calling numbers from Caller ID memory. All numbers with this area code are dialed directly without the area code. If you will be programming numbers within your area code that require all ten digits to be dialed, it is recommended that you do not program this feature.

To change your Caller ID options:

- 1) Press **setup**. The following screen appears.

1▶Auto Talk:	Off
2 CIDCW	:On
3 Area Code:	
- 2) Use the ▲ and ▼ keys to move the cursor to the selection that you would like to change. Press the **select** key to toggle between **On** and **Off** for **Autotalk** and **CIDCW**. Press **select** and use the number keypad to enter or change the area code, then press **select** again.
- 3) After you have made your selections, press **setup** and return the handset to the charging cradle. The status LED flashes, indicating that your setup changes are now effective.

### NOTE

You must subscribe to CIDCW from your phone company in order to use this feature.

### HINT

You may use the ◀ and ▶ keys to toggle between numbers when programming the area code.



If you have no New Caller ID Messages, then the "New" display is blank. Only the "Total" display appears.



Once a Caller ID message has been viewed, it is no longer considered a new message.



If you have no Caller ID messages, then the total is shown as 00.

### ▼ Screening your calls

Caller ID allows you to review caller information before you answer your phone. After the first ring, the display shows the date, time, call count, name, and phone number of the caller. If your Caller ID service is number only, then the name does not appear on the second line.

```
12/21 12:30PM 01  
Schlitz Kaysie  
817-555-1212
```

If a name or number is not available, the display will show a message such as Line Error, Private Number, Private Name, etc.

### ▼ Reviewing Caller ID messages

To review your Caller ID messages, follow the steps below.

- 1) Press **call id**, and the Caller ID summary screen appears. The screen shows the number of new messages and total messages.

```
New : 01  
Total : 02
```

- 2) Press ▼ to scan through the messages. The most recent message appears first, with the date, time, call count, name, and phone number. Press ▲ to scan backwards through the list.

```
12/21 12:30PM 03  
Schlitz Kaysie  
8175551212
```

- 3) Once you have reviewed your oldest message, the following screen appears. Press **call id** to return to standby.

```
End
```



*Once you have viewed all of your Caller ID messages and reach the "End" display, the message list does not cycle back to the beginning. You must press ▲ to view your previous messages.*

### ▼ Calling a Caller ID number

- 1) Press **call id**, and the Caller ID summary screen appears. The screen shows the number of new messages and total messages.

```
New : 01  
Total : 02
```

- 2) Select the number that you would like to dial. Press ▼ to scan forward through the messages and ▲ to scan backwards through the list.

```
12/21 12:30PM 03  
Schlitz Kaysie  
8175551212
```

- 3) Press **talk** and the number automatically dials.

### ▼ Storing a Caller ID number into a memory location

- 1) Press **call id**, and the Caller ID summary screen appears. The screen shows the number of new messages and total messages.

```
New : 01  
Total : 02
```

- 2) Press ▼ or ▲ to find the message that you would like to store, then press **memory** to store the selected message.

```
12/21 12:30PM 03  
Schlitz Kaysie  
8175551212
```

- 3) The select location screen appears. Use the ▲ and ▼ keys to select a blank memory location where you would like to store the number. (If you want to replace an existing number with the Caller ID number, skip to step 5.)

```
Select Location  
1► KAYSIE SCHLITZ  
2 UNIDEN
```

- 4) Press **select**. A confirmation tone sounds, and the number is programmed. (Do not complete steps 5 and 6.)

- 5) If you choose to replace an existing number with the Caller ID number, press **select**, and the following screen appears.

```
Replace Memory?  
Yes  
►No
```

- 6) Use the ▲ key to move the cursor to **Yes** and press **select**. A confirmation tone sounds, and the number is programmed.

## NOTE

If you select **No**, then the Caller ID screen returns.



### ▼ *Deleting a Caller ID message*

To delete a single Caller ID message, follow the steps below.

- 1) Press **call id**, and the Caller ID summary screen appears. The screen shows the number of new messages and total messages.

```
New : 01  
Total : 02
```

- 2) Select the number that you would like to delete. Press ▼ to scan forward through the messages and ▲ to scan backwards through the list.

```
12/21 12:30PM 03  
Schlitz Kaysie  
8175551212
```

- 3) Press **delete**, and the following screen appears.

```
Delete Message?  
► Yes  
No
```

- 4) Press **select** or **delete**. A confirmation tone sounds and the Caller ID screen returns with the next message displayed.

- 5) After you have deleted the oldest Caller ID messages, the display shows **End**. Press **call id** to return to standby.

```
End
```

### ▼ *Deleting all Caller ID messages*

To delete all of your Caller ID messages, follow the steps below.

- 1) Press **call id**, and the Caller ID summary screen appears. The screen shows the number of new messages and total messages.

```
New : 01  
Total : 02
```

- 2) Press **delete**, and the following screen appears.

```
Delete All?  
Yes  
► No
```

- 3) Use the ▲ key to move the cursor to **Yes**, then press **select** or **delete**.

#### NOTE

If you select **No**, then the Caller ID screen returns.

4) A confirmation tone sounds, and the following screen appears.

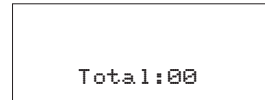

5) Press **call id** to return to standby.

### USING REDIAL

The **redial** key redials the last number dialed. The redialed number can be up to 32 digits long.

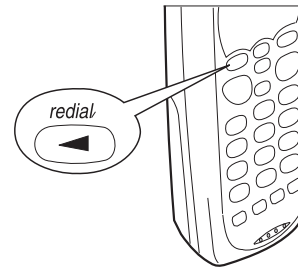

### USING THE TONE FEATURE

If you are dialing in the pulse mode and need to enter tone digits, press **tone** to enter the digits. Once the call has ended, the tone mode is canceled and pulse dialing resumes.

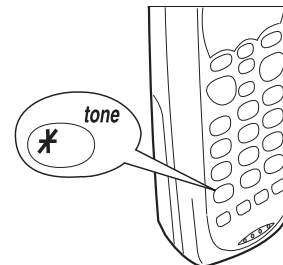

#### NOTE

*The tone feature applies only when the base unit is set to pulse.*

## USING THE PAGE FEATURE

To locate the handset (while it's off the base), press **page** on the base.

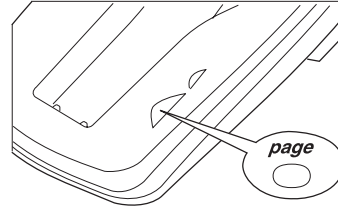

The handset beeps for 60 seconds and displays **Paging**.

**Paging**

Press **talk** on the handset to end paging. Press **talk** again to return to standby.

# TROUBLESHOOTING

## YOUR NEW PHONE

### QUICK REFERENCE CHART

If your phone is not performing to your expectations, please try these simple steps before calling Uniden customer service. If you are still unable to resolve the problem, contact your place of purchase or call customer service at (800) 297-1023.

PROBLEM	SUGGESTION
The charge light won't come on when the handset is placed in the base.	<ul style="list-style-type: none"><li>• Make sure the AC adapter is plugged into the base and wall outlet.</li><li>• Make sure the handset is properly seated in base.</li><li>• Make sure the charging contacts on the handset and base are clean.</li></ul>
The audio sounds weak and/or scratchy.	<ul style="list-style-type: none"><li>• Make sure that the base antenna is in a vertical position.</li><li>• Move the handset and/or base to a different location away from metal objects or appliances and try again.</li></ul>
Can't make or receive calls.	<ul style="list-style-type: none"><li>• Check both ends of the base telephone line cord.</li><li>• Make sure the AC adapter is plugged into the base and wall outlet.</li><li>• Disconnect the AC adapter for a few minutes, then reconnect it.</li><li>• Place the handset back on the charging cradle for a few seconds. The <b>status</b> LED will blink indicating that the phone has been reset.</li></ul>

PROBLEM	SUGGESTION
The handset doesn't ring or receive a page.	<ul style="list-style-type: none"><li>• The Nickel-Cadmium battery pack may be weak. Charge the battery on the base unit for 15-20 hours.</li><li>• The handset may be too far away from the base unit.</li><li>• Place the base unit away from appliances or metal objects.</li><li>• Place the handset back on the charging cradle for a few seconds. The <b>status</b> LED will blink indicating that the phone has been reset.</li></ul>

SPECIFICATIONS  
OF YOUR NEW PHONE

### GENERAL

The EXS9600 complies with FCC Parts 15 and 68.

Frequency control: PLL

Modulation: Direct Sequence Spread Spectrum; DBPSK

Operating temperature: 0° to 50° C (+32° F to +122° F)

### BASE

Frequency: 904.2 to 925.8 MHz (20 channels)

Power requirements: 9V 350 mA (from AC adapter)

Size: 5-1/2in.(W) x 3-3/4in. (D) x 10in. (H)

Weight: Approx. 17.8oz. (including optional battery)

### HANDSET

Frequency: 904.2 to 925.8 MHz (20 channels)

Power requirements: Rechargeable Nickel Cadmium battery pack

Size (without antenna): 2-1/4in. (W) x 1-3/4in. (D) x 7-1/4in. (H)

Weight: Approx. 9.3oz. (including battery)

Battery: BT-990

Capacity 600 mAh, 3.6V

Talk mode 4 hours

Standby mode 7 days

*Specifications, features, and availability of optional accessories are all subject to change without prior notice.*

# CONTROLS

## AND FUNCTIONS

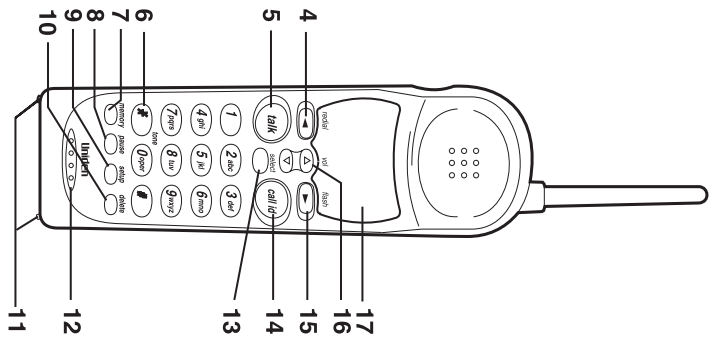
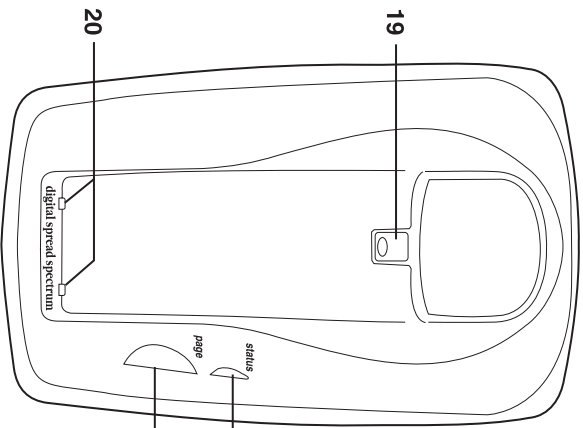
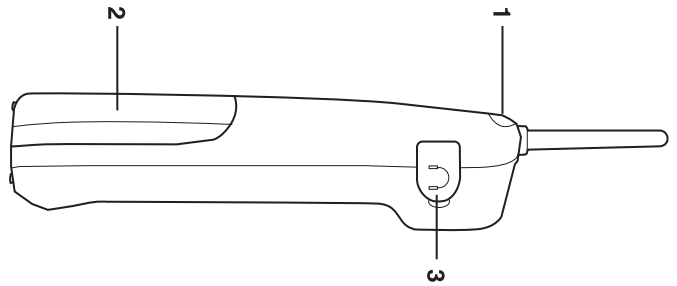
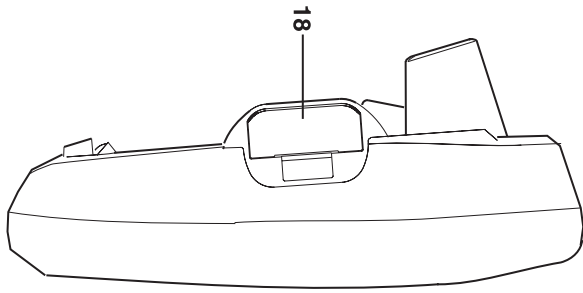

1. Slot Cover
2. Battery Compartment
3. Headset Jack
4. Redial
5. Talk
6. Tone
7. Memory
8. Pause
9. Setup
10. Delete
11. Charging Contacts
12. Handset Microphone
13. Select
14. Call ID
15. Flash
16. Volume Up and Down
17. Handset Display
18. Spare Battery Compartment
19. Handset Retainer Clip
20. Charging Contacts
21. Page
22. Status LED
23. Beltclip Holder
24. Desktop/Wall Mount Adapter
25. Pulse/Tone
26. DC in (9V)
27. Tel Line

